

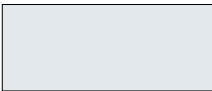







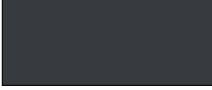

Product design: Andreas Bürki and bigla team

Powder-coated metal

	silver 180*
	aluminium 190*
	anthracite metallic 1188**
	black 157* 1157** NCS S 9000-N
	anthracite 158* 1158** NCS S 7502-B
	light grey 159* 1159** NCS S 2502-B
	white grey 160* 1160** NCS S 0502-B
	red 165* 1165** NCS S 2570-Y90R
	dark blue 177* 1177** NCS S 7020-R80B
	yellow 156* 1156** NCS S 1070Y

* smooth ** fine texture



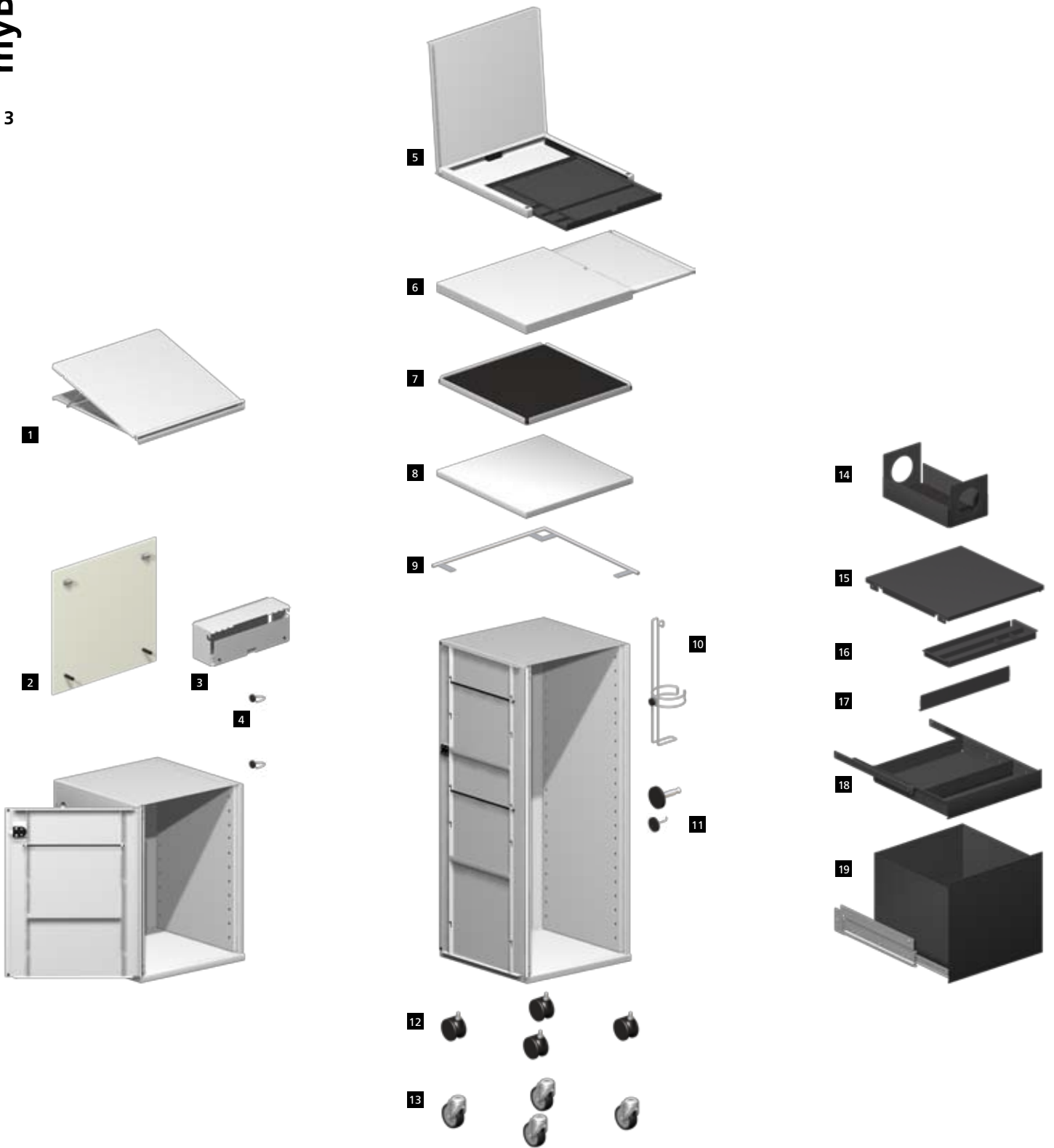

- 1** Copy holder, adjustable angle
- 2** Display panel
- 3** Cable box
- 4** Cable clip, magnetic

- 5** Hinged top with material drawer
- 6** Top with pullout surface
- 7** Tray top
- 8** Basic top
- 9** Railing
- 10** Bottle holder
- 11** Magnets
- 12** Furniture casters
- 13** Industrial casters

- 14** CD box
- 15** Adjustable shelf
- 16** Material tray
- 17** Divider
- 18** Basic drawer 6 cm – max. capacity 5 kg
- 19** A4 drawer – max. capacity 15 kg (with counterweight)

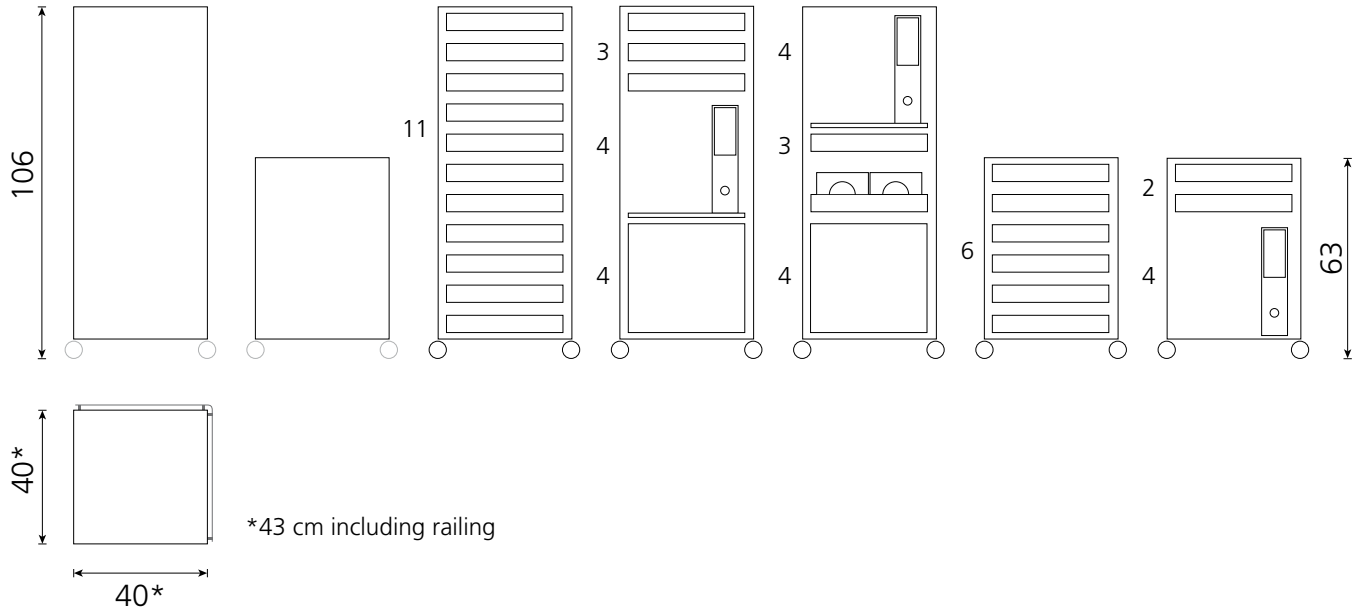

Examples



Example 1



Example 2



Example 3

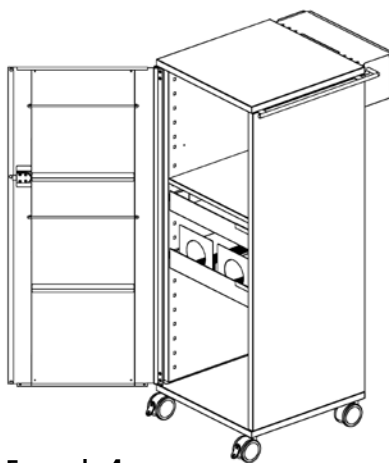

Example 4



Example 5